

tresirmaos		Edição:	Data alteração:
Código / Produto: 218.009_Williamsburg_30"_Vanity		Material:	Data criação: 20/07/2020
Código / Peça : / movel montado		QTDE.	Desenho: Marcelo
Dimensões em (mm): x x	M ² :	M ³ :	Peso: N/A
			Página: 1

Lista de peças							
Item	Código	Peça	Quant.	Comp. (mm)	Larg. (mm)	Esp. (mm)	Material
1	218.009.10	lateral direita montada	1				
1.1	218.009.12	pe direito frontal	1	865,0	45,0	45,0	Pinus(Finger)
1.2	218.009.11	pe direito traseiro	1	865,0	45,0	45,0	Pinus(Finger)
1.3	218.009.09	Almofada lateral maior	1	462,0	539,0	6,0	MDF CRU
1.5	218.009.05	Travessa superior lateral	2	450,0	43,0	18,0	Pinus
1.8	218.009.06	Travessa corrediça	1	450,0	50,0	26,0	Pinus
1.9	218.009.04	Travessa central lateral	1	450,0	43,0	18,0	Pinus
1.10	218.009.08	Almofada lateral menor	1	462,0	188,0	6,0	MDF CRU
1.11	218.009.07	travessa interna dobradiça	1	530,0	50,0	18,0	Pinus
2	218.009.28	travessa frontal superior	1	672,0	30,0	18,0	Pinus
3	218.009.01	lateral esquerda montada	1				
3.1	218.009.02	pe esquerdo frontal	1	865,0	45,0	45,0	Pinus(Finger)
3.2	218.009.03	pe esquerdo traseiro	1	865,0	45,0	45,0	Pinus(Finger)
3.3	218.009.09	Almofada lateral maior	1	462,0	539,0	6,0	MDF CRU
3.5	218.009.05	Travessa superior lateral	2	450,0	43,0	18,0	Pinus
3.8	218.009.06	Travessa corrediça	1	450,0	50,0	26,0	Pinus
3.9	218.009.04	Travessa central lateral	1	450,0	43,0	18,0	Pinus
3.10	218.009.08	Almofada lateral menor	1	462,0	188,0	6,0	MDF CRU
3.11	218.009.07	travessa interna dobradiça	1	530,0	50,0	18,0	Pinus
7	218.009.15	travessa superior traseira	1	672,0	220,0	18,0	MDF CRU
23	218.009.14	Fundo	1	672,0	527,0	18,0	MDF CRU
24	218.009.13	travessa inferior frontal	1	672,0	50,0	18,0	Pinus
25	218.009.16	Travessa superior frontal	1	672,0	50,0	18,0	Pinus
28.1	218.009.22	Lateral Direita Gaveta	1	400,0	130,0	14,0	Pinus(Finger)
28.2	218.009.23	Lateral Esquerda Gaveta	1	800,0	300,0	18,0	Pinus(Finger)
28.3	218.009.24	Fundo de Gaveta	1	631,0	398,0	3,0	MDF CRU
28.4	218.009.21	Traseiro de gaveta	1	618,0	128,0	14,0	Pinus(Finger)
28.9	218.009.25	Frente montada	1				
28.9.1	218.009.26	Frente de Gaveta	1	666,0	174,0	15,0	MDF CRU
28.9.2	218.009.30	Aplique maior gaveta	2	566,0	12,0	12,0	Pinus
28.9.3	218.009.27	Aplique menor gaveta	2	74,0	12,0	12,0	Pinus
28.10	218.009.29	Suporte fundo de gaveta	1	386,0	45,0	14,0	Pinus
29	218.009.17	Porta montada	2				
29.1	218.009.18	Porta	1	525,0	332,0	15,0	MDF CRU
29.2	218.009.19	Aplique maior porta	2	425,0	12,0	12,0	Pinus
29.3	218.009.20	Aplique menor porta	2	232,0	12,0	12,0	Pinus

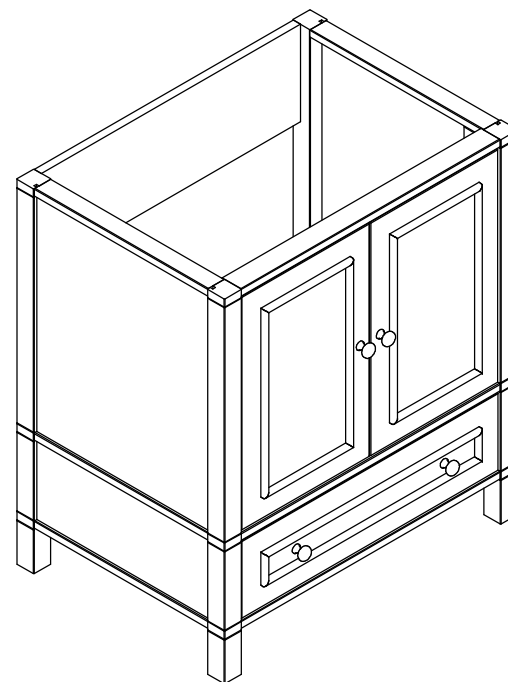

tresirmaos		Edição:	Data alteração:
Código / Produto: 218.009_Williamsburg_30"_Vanity		Material:	Data criação: 20/07/2020
Código / Peça : / movel montado		QTDE.	Desenho: Marcelo
Dimensões em (mm): x x	M² :	M³ :	Peso: N/A
			Página: 2