

ASSEMBLY INSTRUCTIONS

30" Diameter Bistro Dining Table

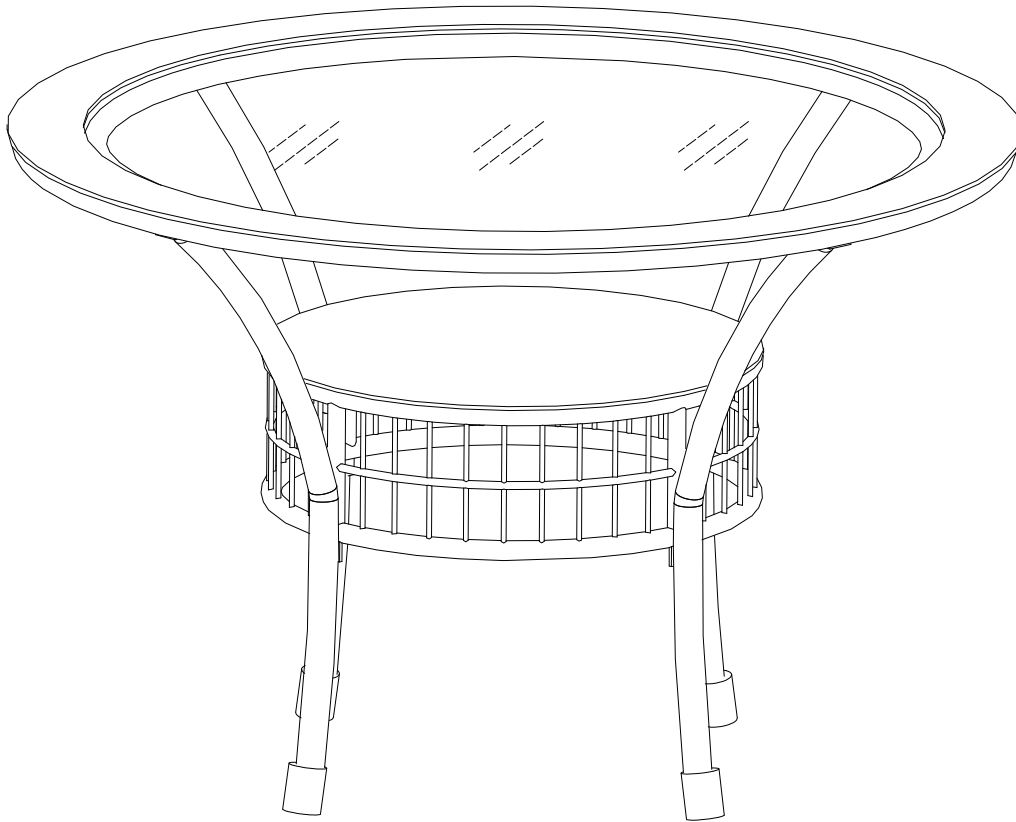

REPLACEMENT PARTS

Please do not contact the company purchased from as we can help you faster.

Order replacement parts and hardware at "boltonfurniture.com"

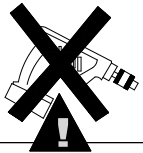

. Use of power tool to assemble this product will invalidate any claim and damage this product making it unsafe!!!
. Please assemble on a clean soft surface to avoid damage.

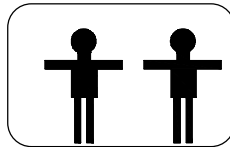

+

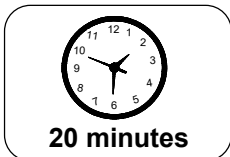

20 minutes

Tool Included

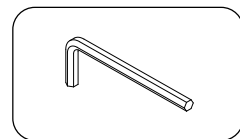

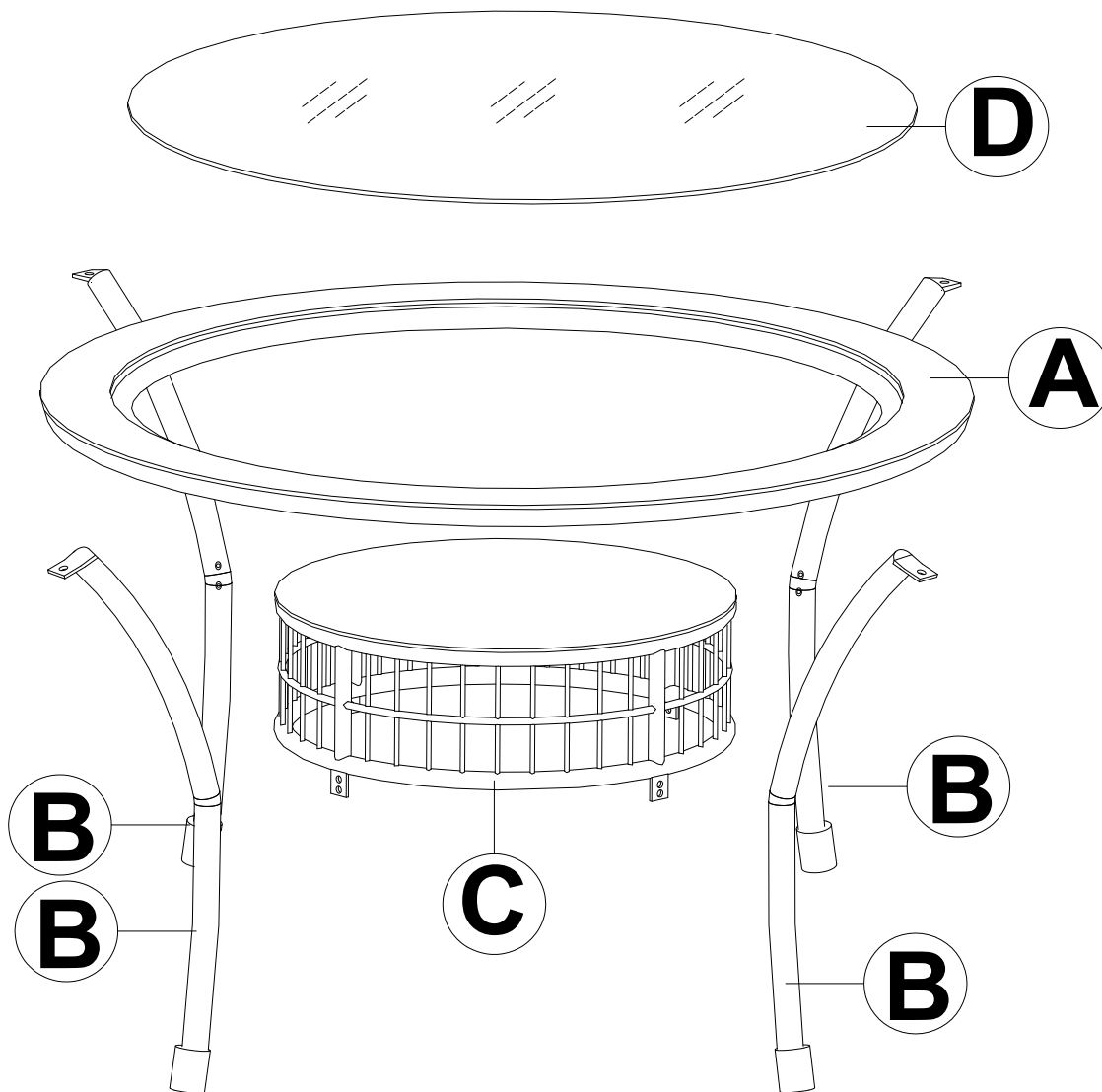

www.boltonfurniture.com

Part List- 30" Diameter Bistro Dining Table

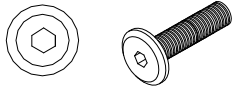

Identifying the hardware-Identify the hardware using the illustrations below.

E  **08**
M6X30mm

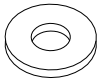

F  **04**
M6X20mm

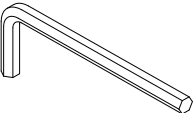
G  **12**

H  **01**



www.boltonfurniture.com

Step 1

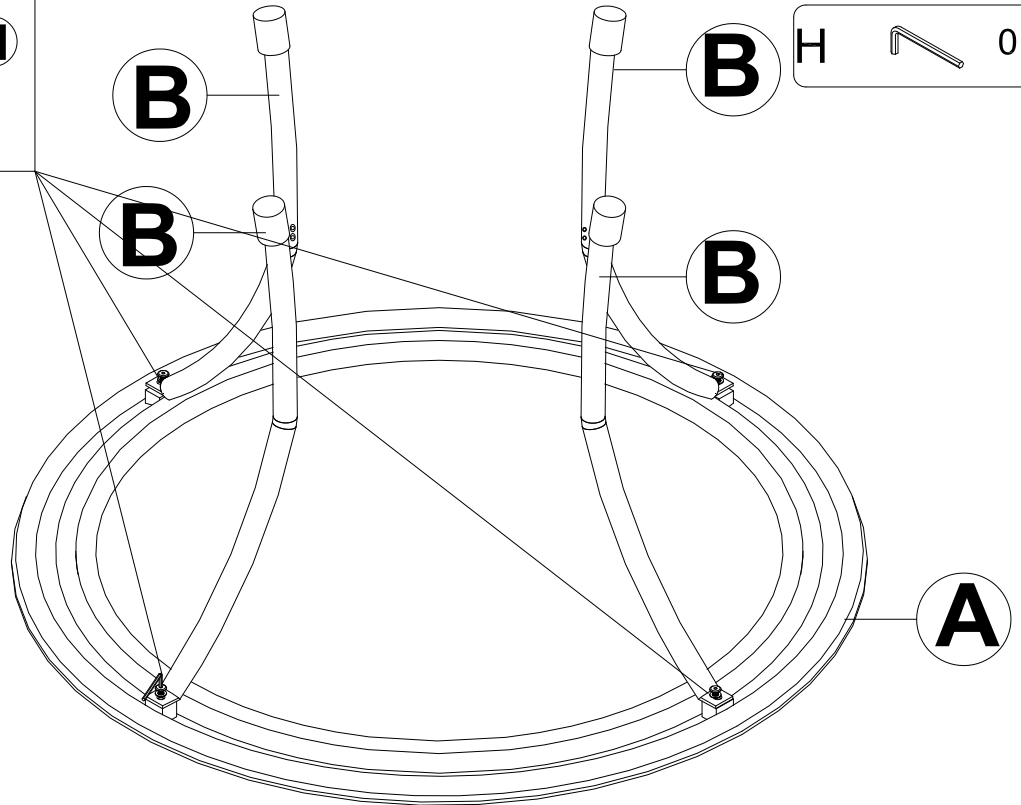
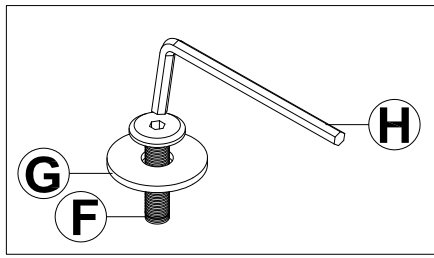
F		04
M6X20mm		
G		04
H		01



Step 2

E		08
M6X30mm		
G		08
H		01

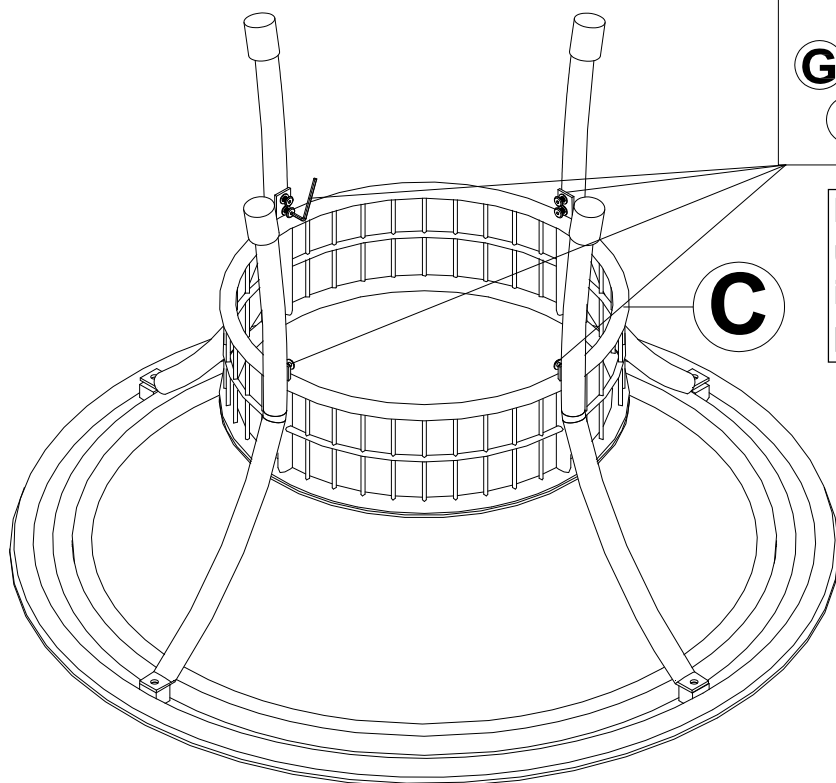
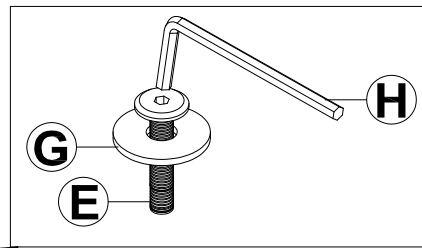

Do not fully tighten until all screws are in place and properly aligned

Step 3

