

ASSEMBLY INSTRUCTIONS

Dining Chair

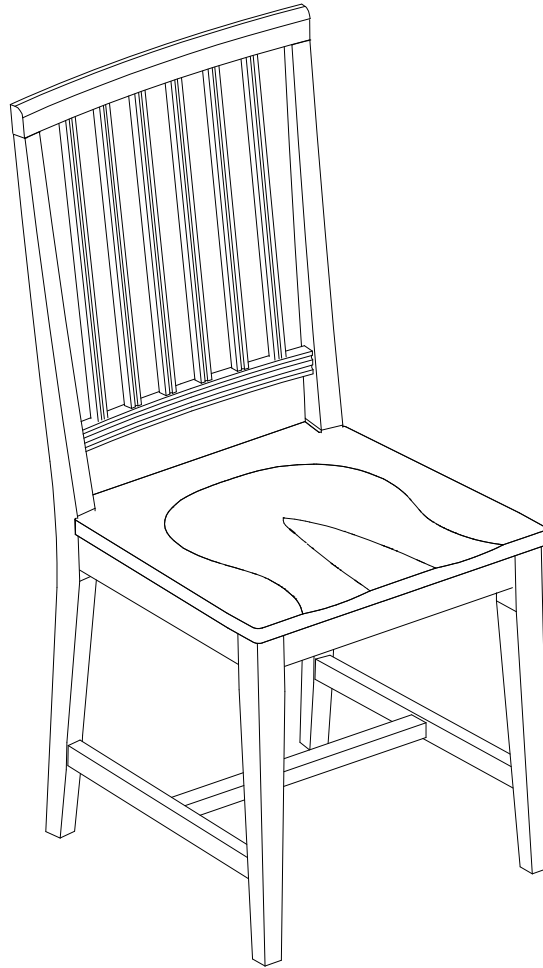

REPLACEMENT PARTS

Please do not contact the company purchased from as we can help you faster.

Order replacement parts and hardware at "boltonfurniture.com"

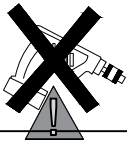
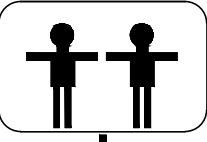
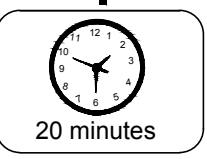
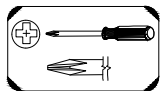
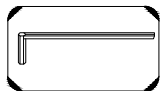
 <p>. Use of power tool to assemble this product will invalidate any claim and damage this product making it unsafe!!! . Please assemble on a clean soft surface to avoid damage.</p>	 <p>+</p>  <p>20 minutes</p>	<p><u>Tool Required</u></p>  <p>(Not included)</p>  <p>(Included)</p>
--	--	---

Dining Chair

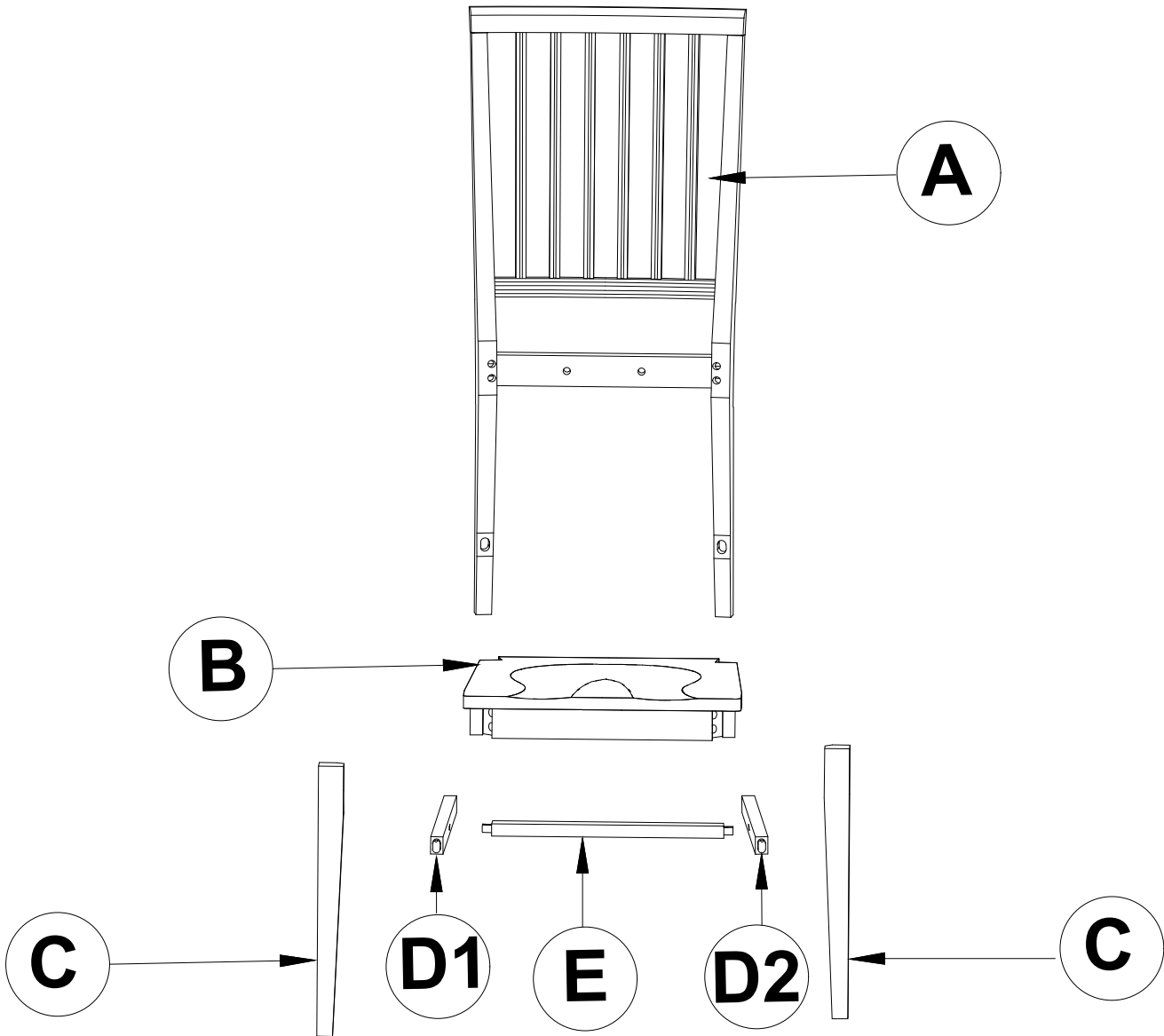

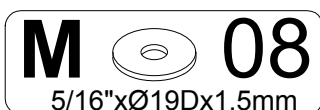
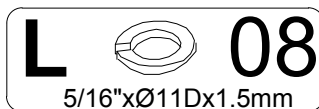
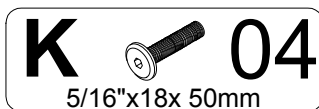
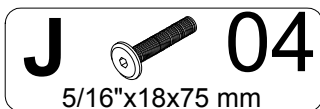
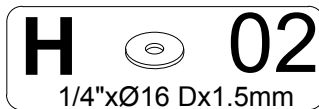
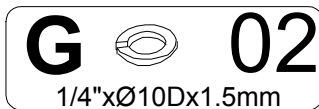

Identifying the hardware-Identify the hardware using the illustrations below.



Step 1

F  **02**
1/4"x20x45 mm

G  **02**
1/4"xØ10Dx1.5mm

H  **02**
1/4"xØ16 Dx1.5mm

N  **01**
ALLEN WRENCH

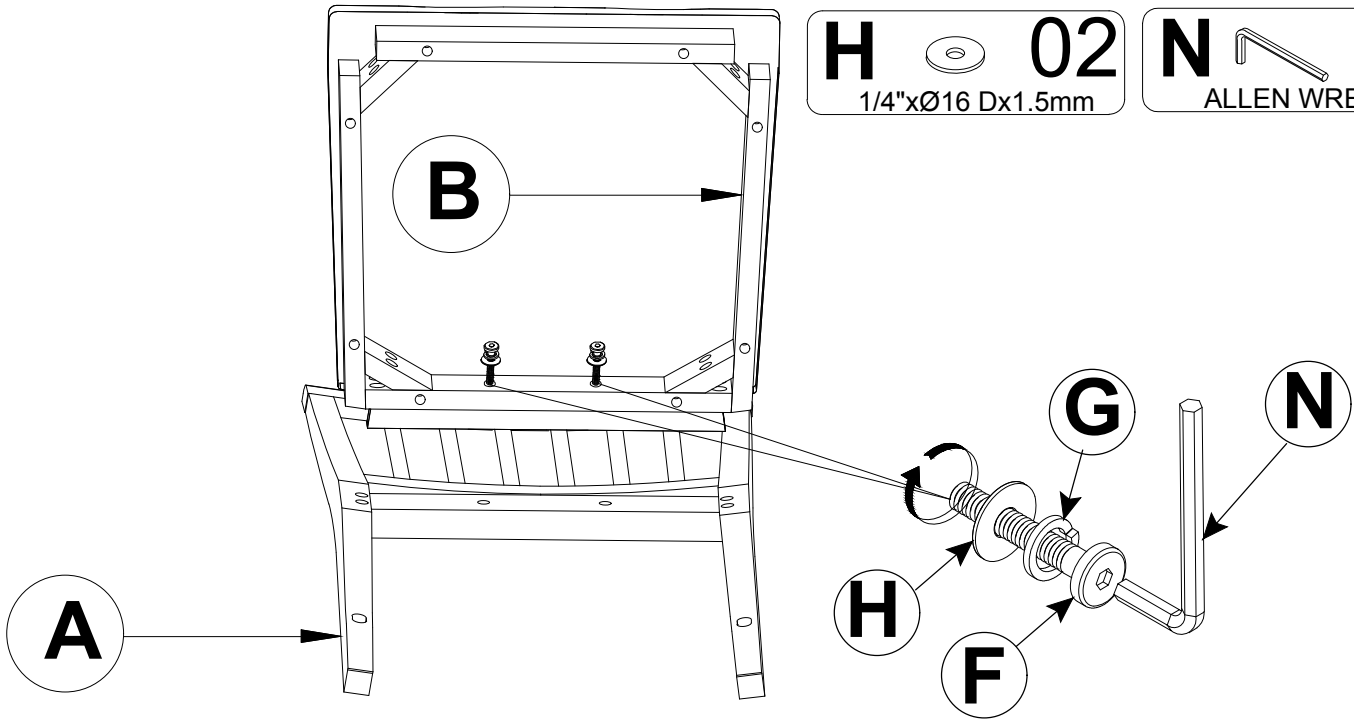

Step 2

J  **04**
5/16"x18x75 mm

L  **04**
5/16"xØ11Dx1.5mm

M  **04**
5/16"xØ19Dx1.5mm

N  **01**
ALLEN WRENCH

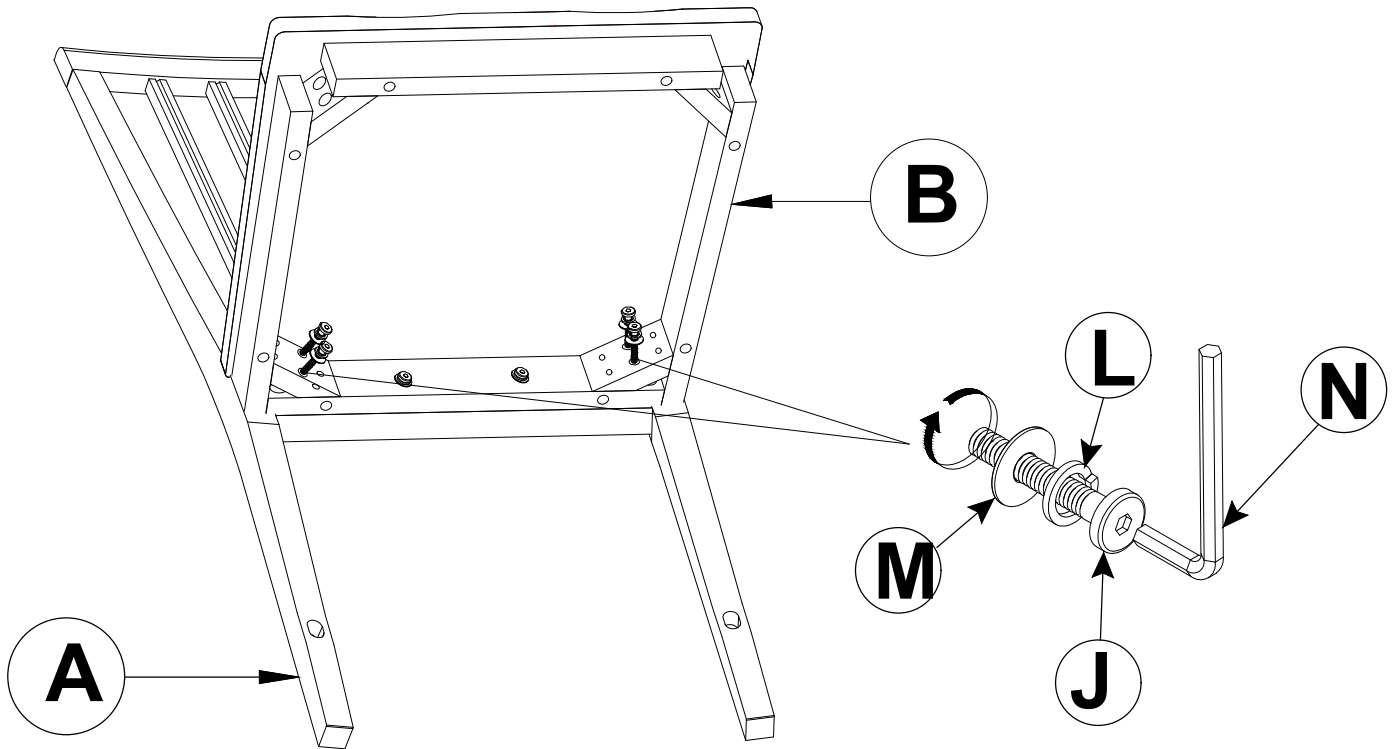

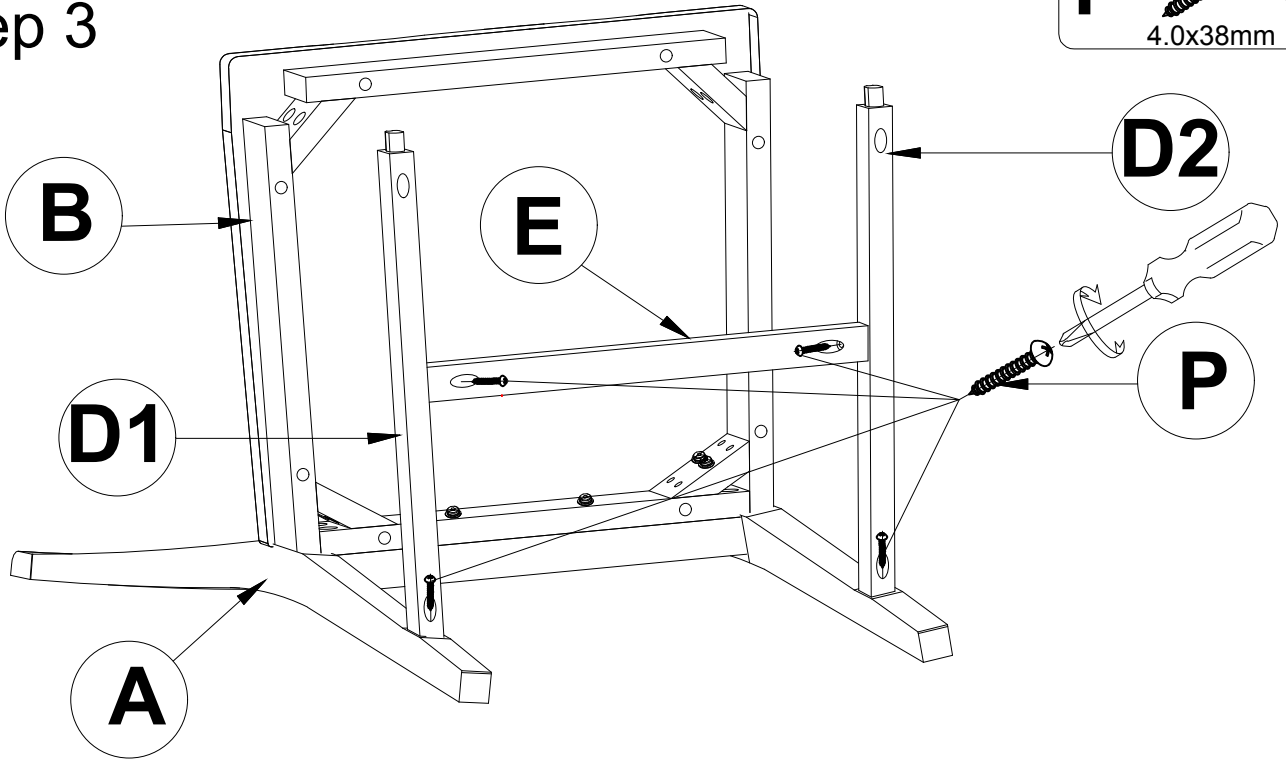

Step 3

P  **04**
4.0x38mm



Step 4

K  **04**
5/16"x18x 50mm

L  **04**
5/16"xØ11Dx1.5mm

M  **04**
5/16"xØ19Dx1.5mm

N  **01**
ALLEN WRENCH

P  **02**
4.0x38mm

