

# ASSEMBLY INSTRUCTIONS

## Upholstered Chair

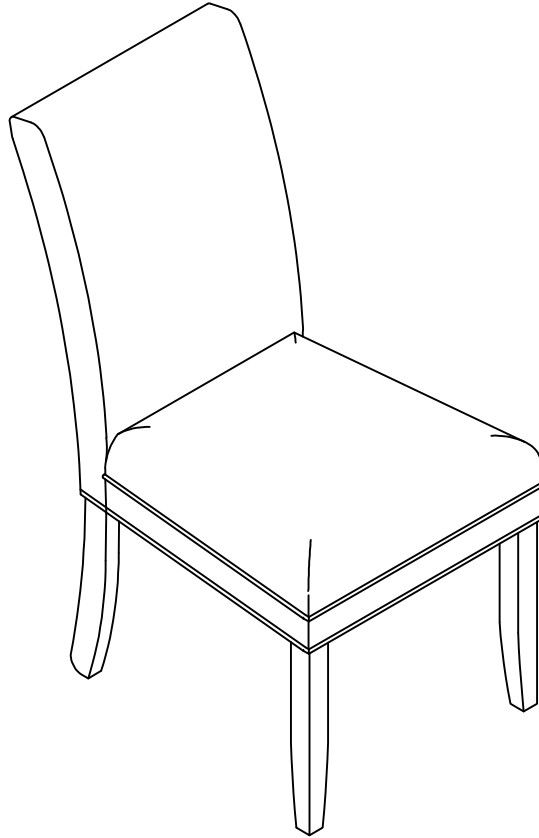

### REPLACEMENT PARTS

Please do not contact the company purchased from as we can help you faster.

Order replacement parts and hardware at "[boltonfurniture.com](http://boltonfurniture.com)"



. Use of power tool to assemble this product will invalidate any claim and damage this product making it unsafe!!!  
. Please assemble on a clean soft surface to avoid damage.

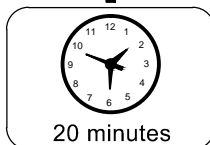
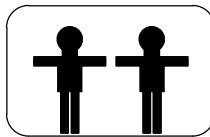

### Tool Included

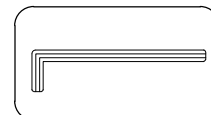

# Upholstered Chair

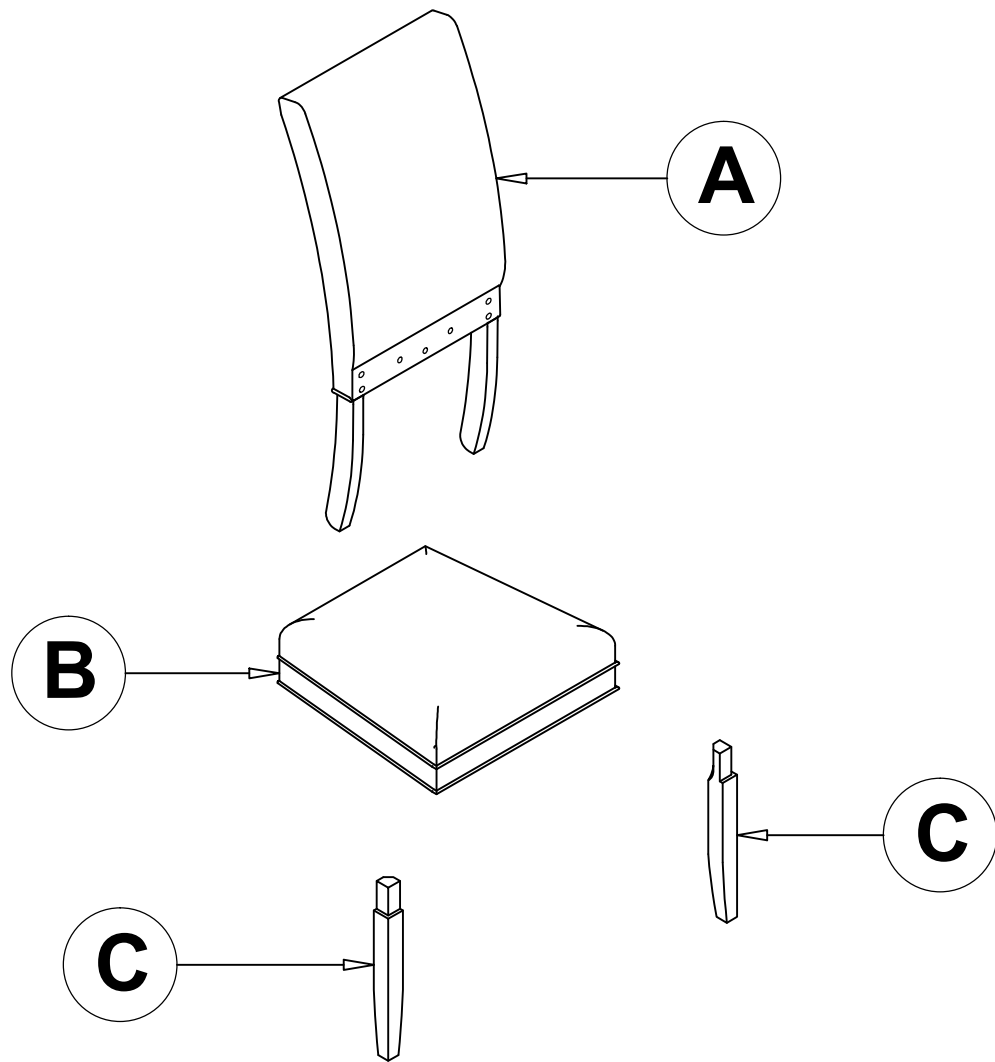

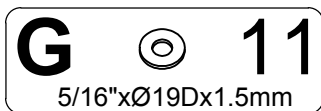
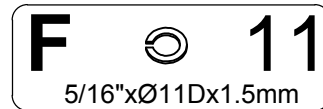
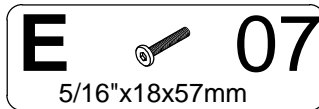
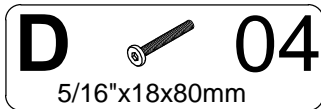

**Identifying the hardware** - Identify the hardware using the illustrations below.



# Step 1

**E**  **03**  
5/16"x18x57mm

**F**  **03**  
5/16"xØ11Dx1.5mm

**G**  **03**  
5/16"xØ19Dx1.5mm

**H**  **01**  
ALLEN WRENCH

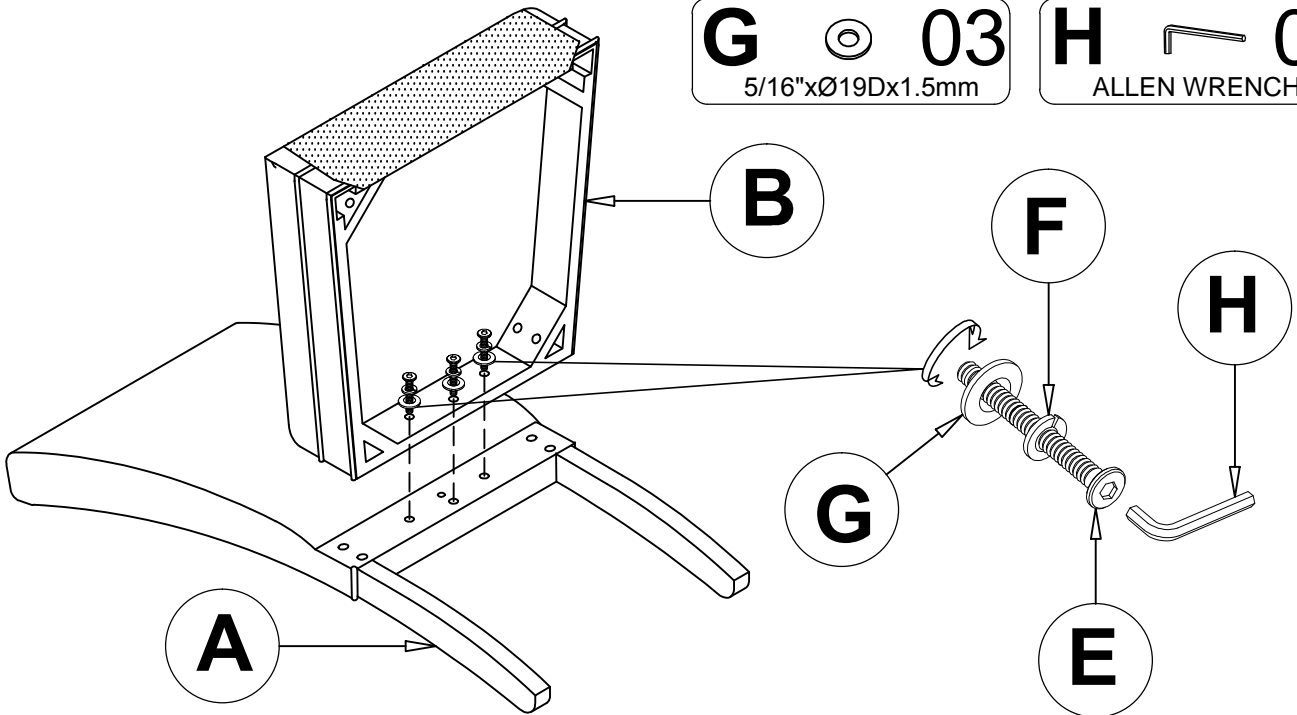

# Step 2

**D**  **04**  
5/16"x18x80mm

**F**  **04**  
5/16"xØ11Dx1.5mm

**G**  **04**  
5/16"xØ19Dx1.5mm

**H**  **01**  
ALLEN WRENCH

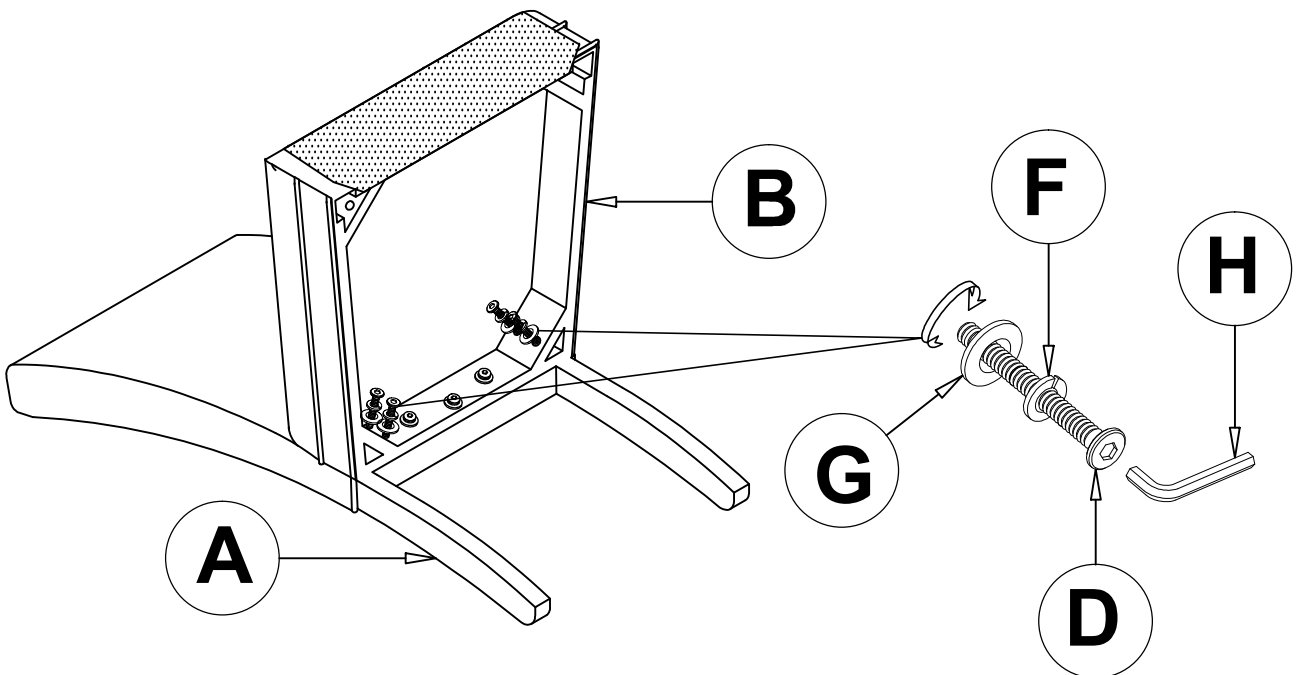

# Step 3

**E**  **04**  
5/16"x18x57mm

**F**  **04**  
5/16"xØ11Dx1.5mm

**G**  **04**  
5/16"xØ19Dx1.5mm

**H**  **01**  
ALLEN WRENCH

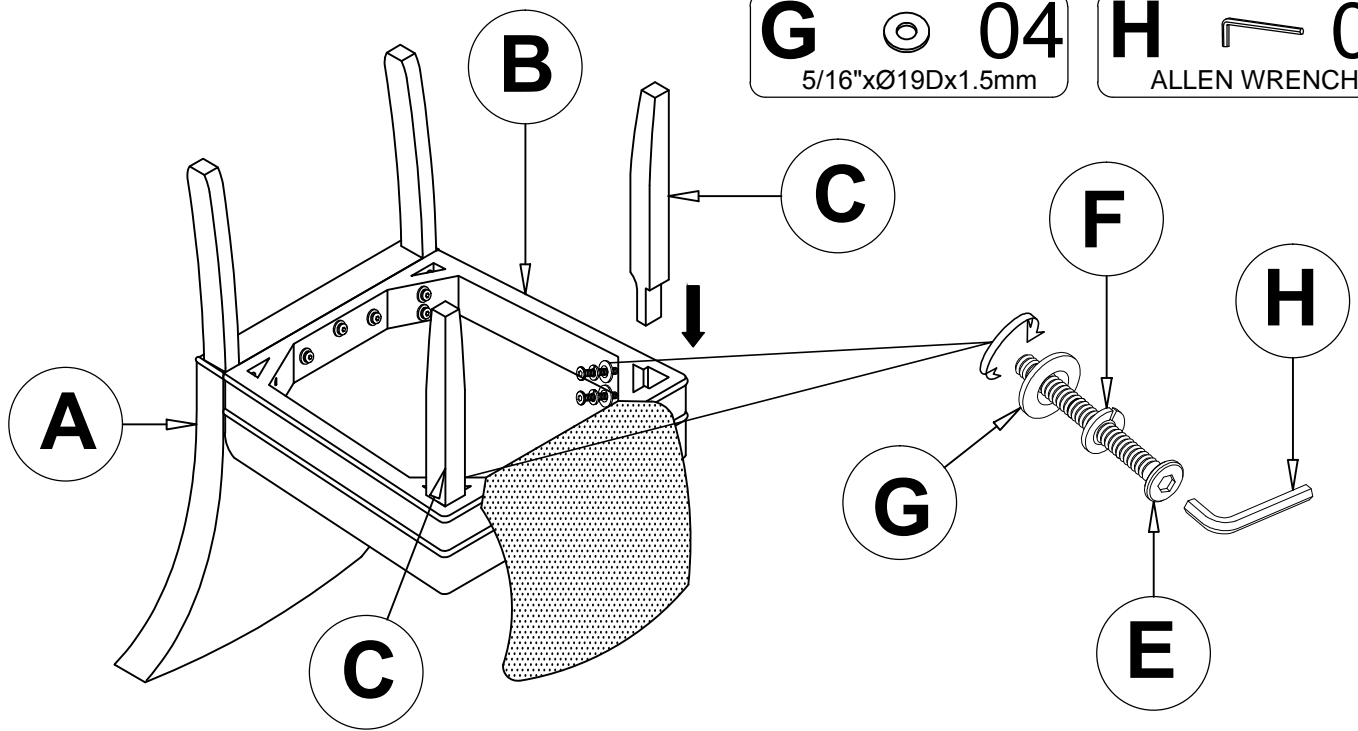

# Step 4

