

ASSEMBLY INSTRUCTIONS

Corner Storage Cabinet w/Doors & Open Shelving

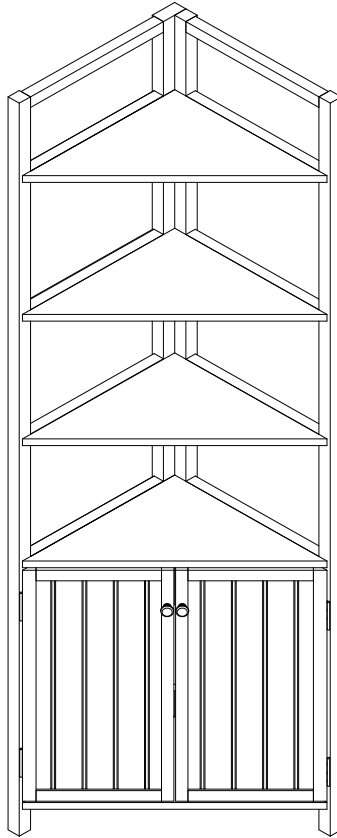

REPLACEMENT PARTS

Please do not contact the company purchased from as we can help you faster.

Order replacement parts and hardware at "boltonfurniture.com"

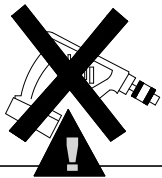

- . Use of power tool to assemble this product will invalidate any claim and damage this product making it unsafe!!!
- . Please assemble on a clean soft surface to avoid damage.

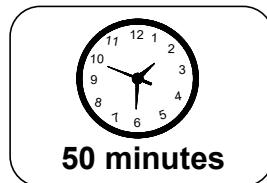
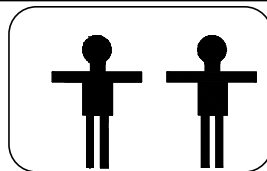

50 minutes

Tool Included

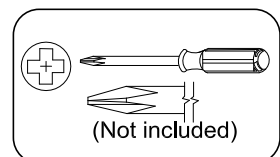
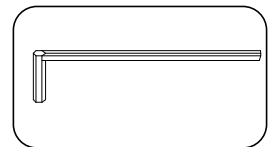





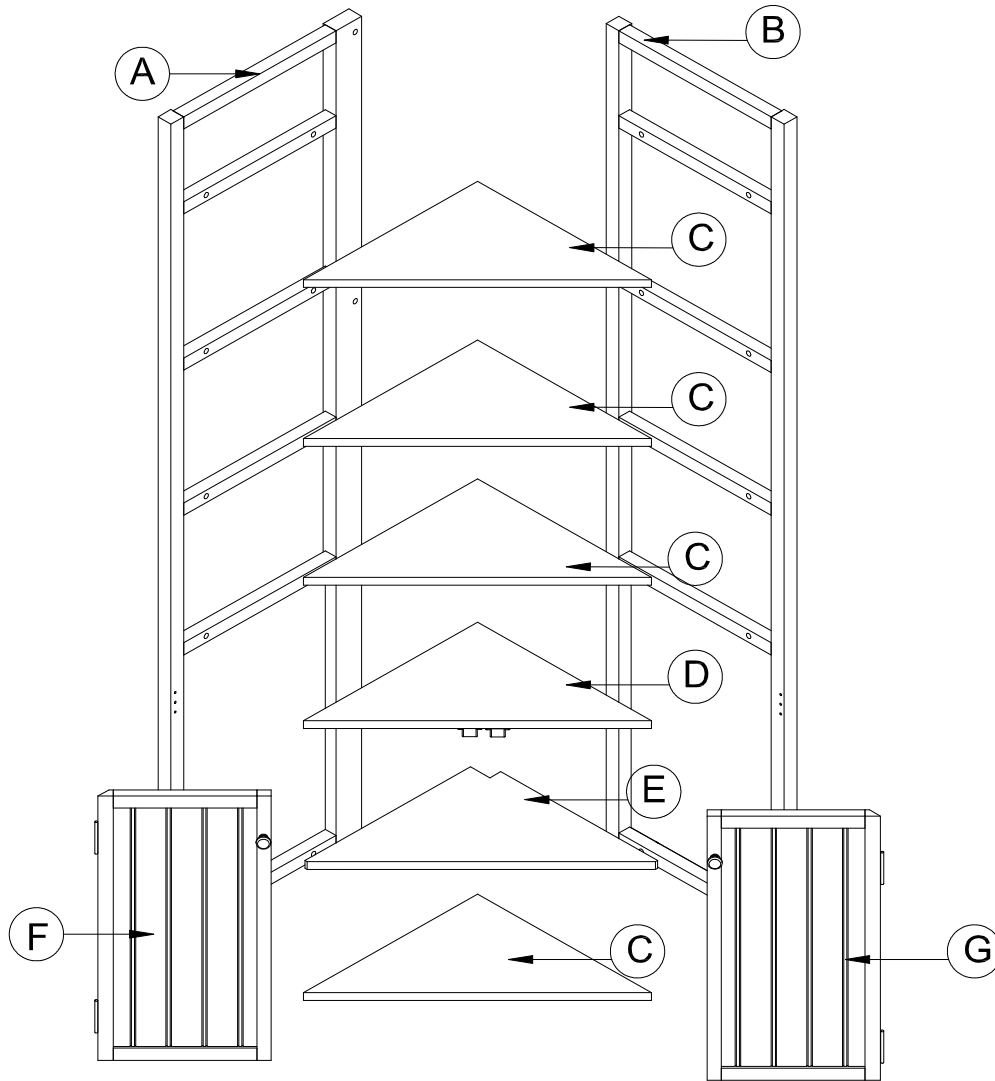

www.boltonfurniture.com

Part List-Corner Storage Cabinet w/Doors & Open Shelving

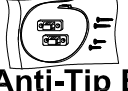

Identifying the hardware-Identify the hardware using the illustrations below.

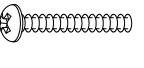
H  20 M6X35mm	I  04 M6X45mm	J  12 4*15mm	K  01
L  03	M  01 Anti-Tip Bag	N  02	O  02

www.boltonfurniture.com

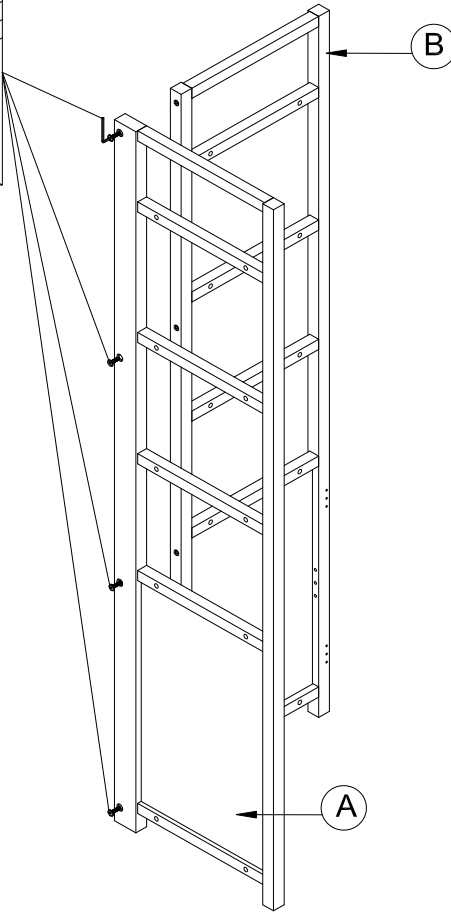
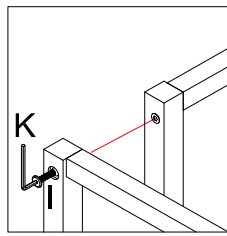

STEP 1

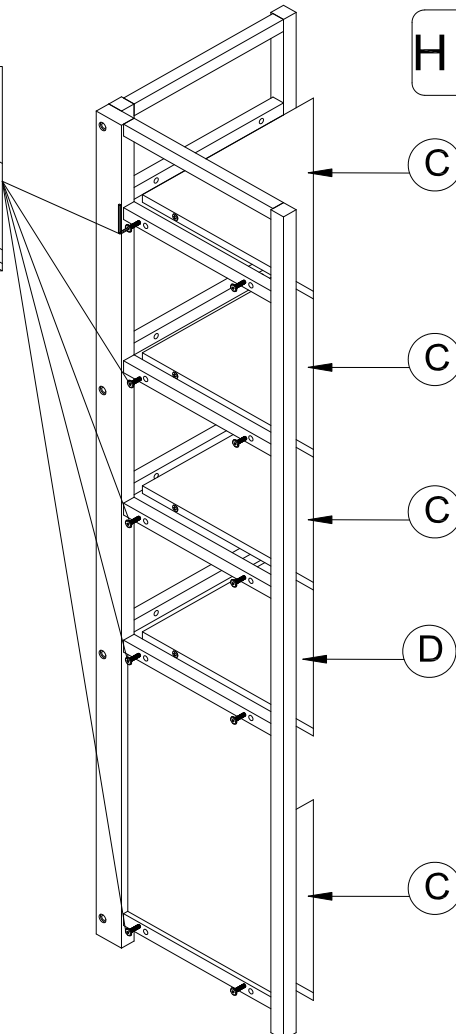
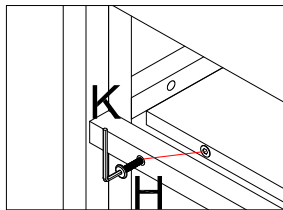

I		04	K		01
M6X45mm					

STEP 2



H		10	K		01
M6X35mm					

STEP 3

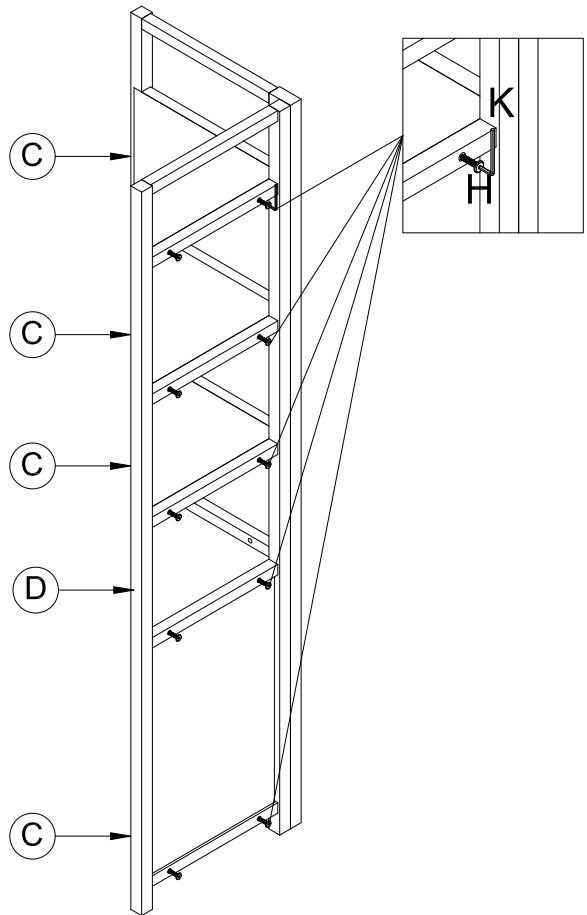

H		10	K		01
M6X35mm					

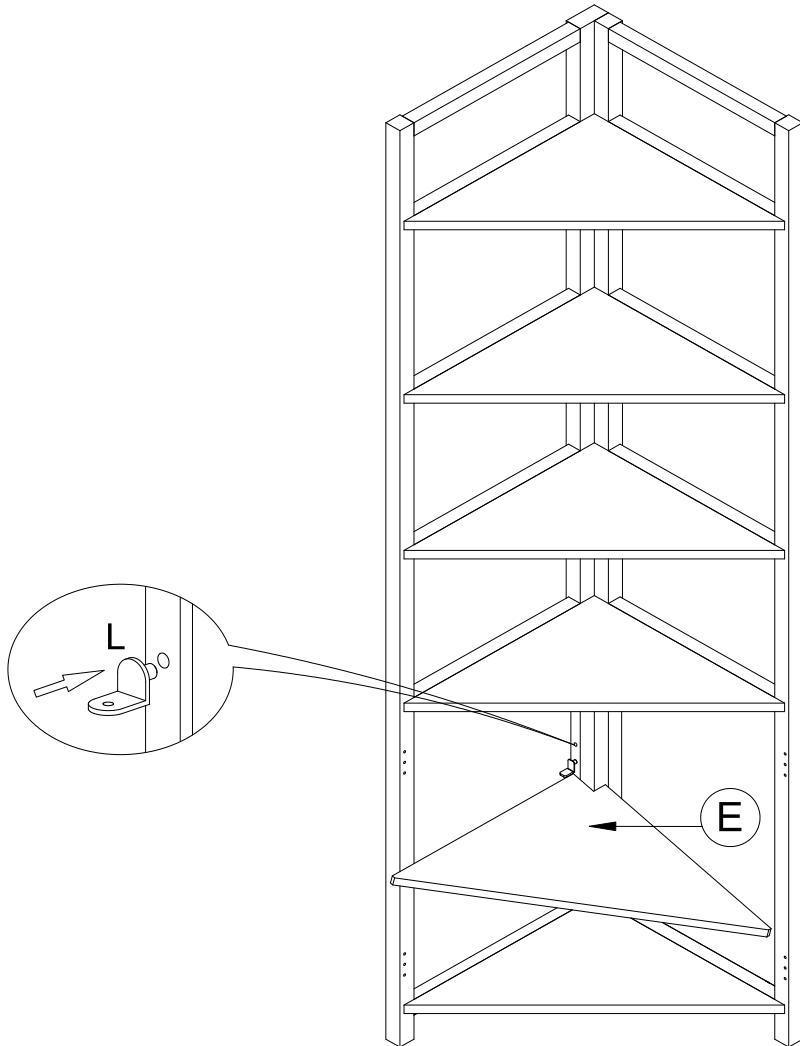

STEP 4



L		03
---	--	----

STEP 5

J  **12**
4*15mm

 
(Not included)

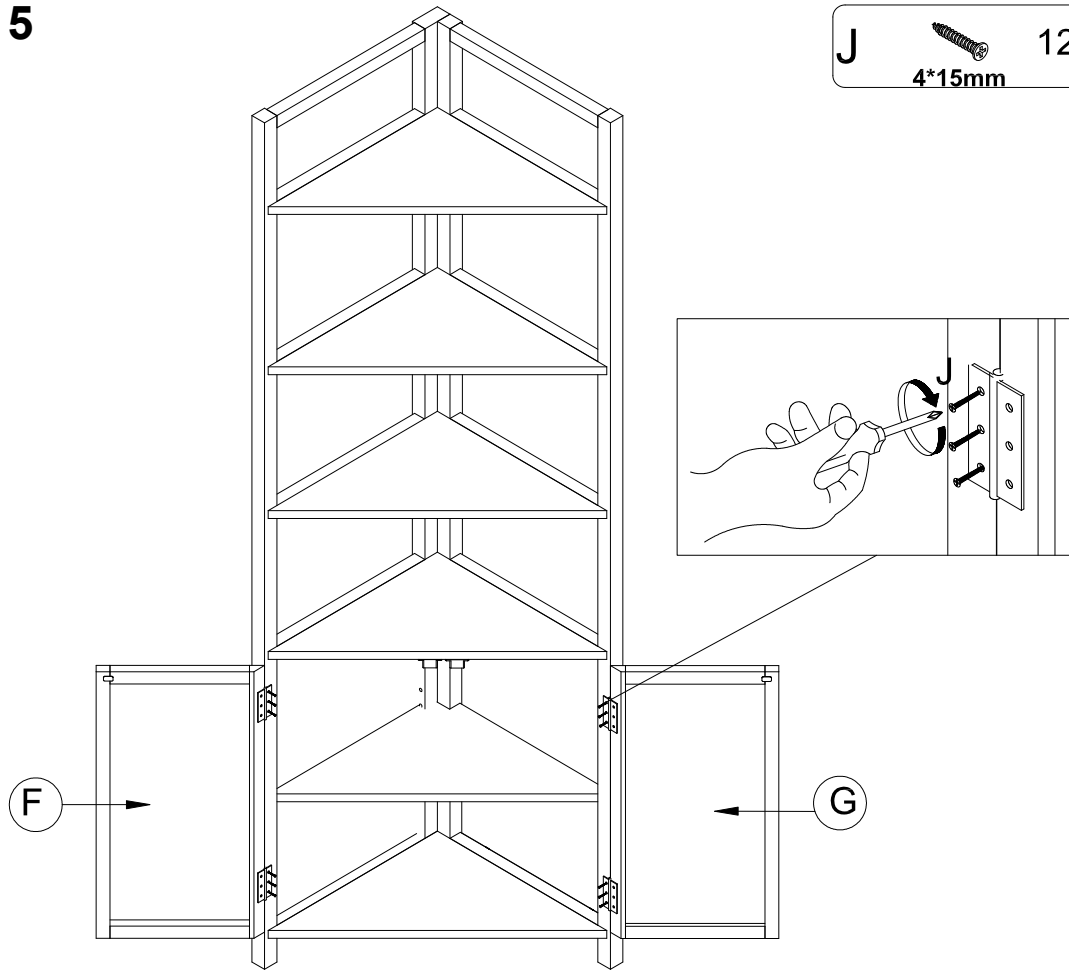



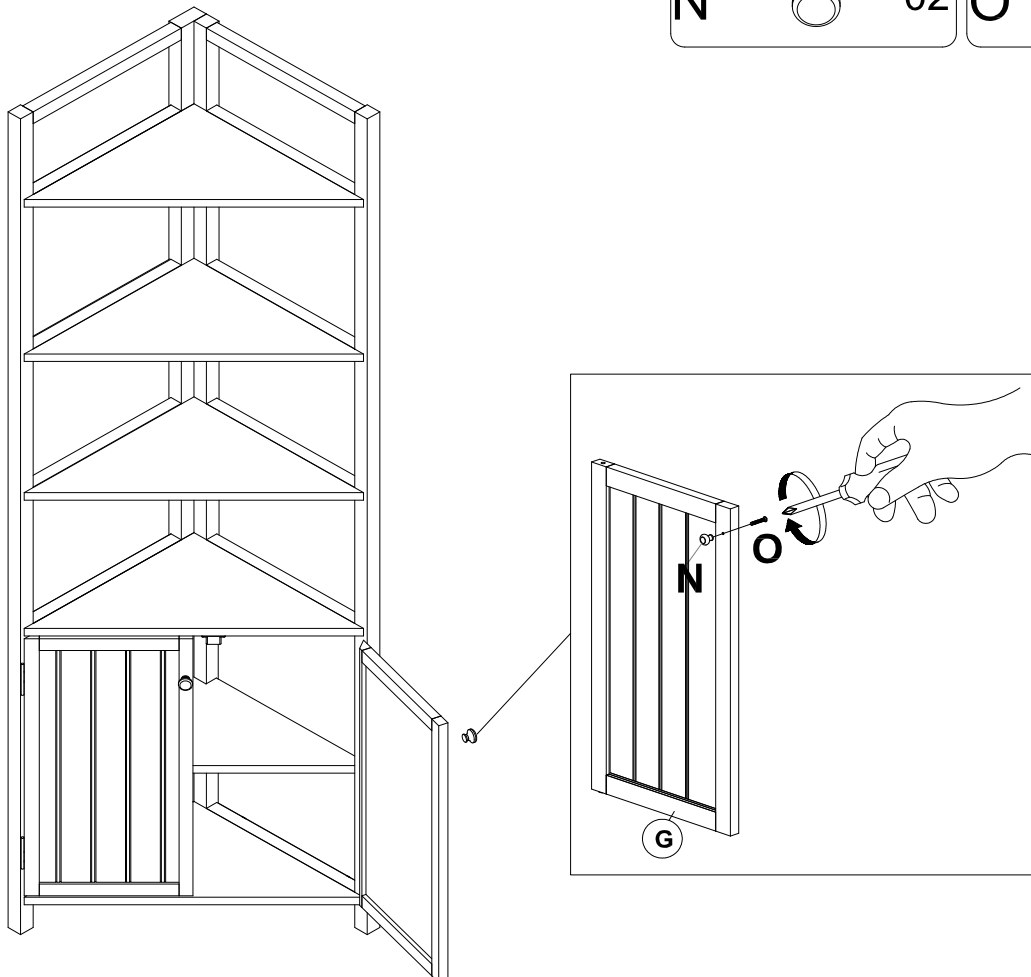

STEP 6

N  **02**

O  **02**



"M" Anti-Tip Bag

A	 4x14 Screw	02	C	 Plastic wall bracket	02
B	 4x35 Screw	02	D	 Nylon strap 140mm	01

Secure to Stud behind Wallboard

