

# Alaterre Furniture

## Shaker Cottage 2 Shelf End Table

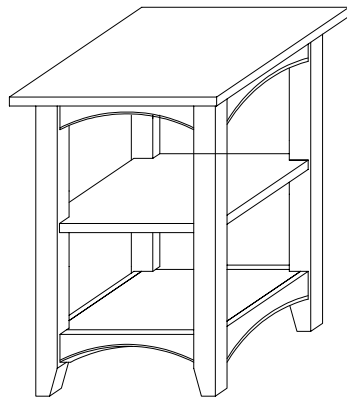





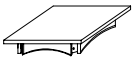

Thank you for purchasing our Shaker Cottage 2 Shelf End Table. **We have found it helpful to have a second person present in at least one step of the assembly.**

---

### 2 Shelf End Table Assembly Instructions

Lay out all parts on a "non-abrasive" surface to avoid scratching furniture.

NO.	DRAWING	DESCRIPTION	Q'TY	NO.	DRAWING	DESCRIPTION	Q'TY
A		Top Unit	1	E		Hex Bolt-45mm	8
B		Shelf	1	F		Wood Dowel	4
C		Bottom	1	G		Allen Wrench	1
D		Leg	4				

---

## PARTS

### Step 1

Read through these instructions thoroughly before beginning assembly. We have found this to be of great value when first assembling this product.

### Step 2

Remove all parts and hardware from packing material. Wooden pieces should be placed on a non abrasive surface (like the carton or carpet) to prevent damage to the finish.

### Step 3

Lay Top Unit (A) upside down and attach 2 Posts (D) by using 2 Hex Bolts 45mm (E).

**Note:** It will help to have a second person at this time to assist in assembly.

Turn onto side, attach Shelf (B) to Posts (D) by using 2 Wooden Dowels (F).

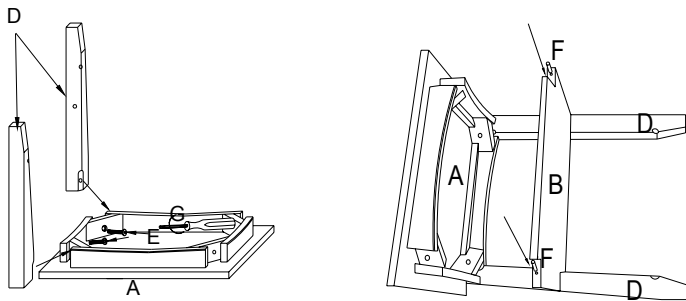

### Step 4

Attach Bottom (C) using 2 Hex Bolts 45mm (E).

Repeat same procedure with other 2 Posts (D).

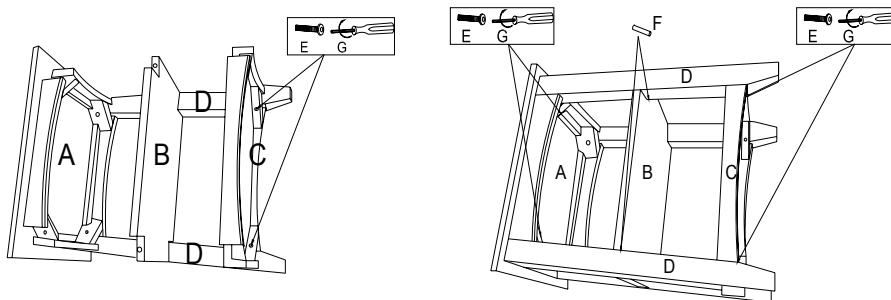

---

## CARE

Clean with mild soap and wipe dry.

---

## REPLACEMENT PARTS

Please do not contact the company you purchased from as we can help you faster.

Order replacement parts and hardware at "[alaterrefurniture.com](http://alaterrefurniture.com)"